

F/T Systems Data Sheet

Floor Beams installed in accordance with Rackham Housefloors design

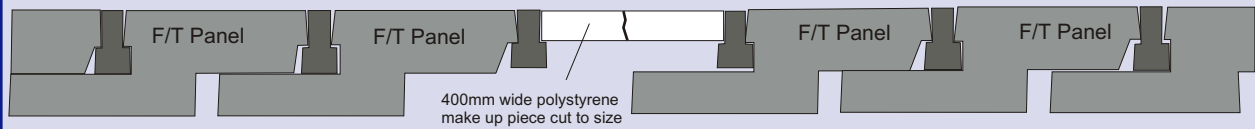

Typical Floor Construction

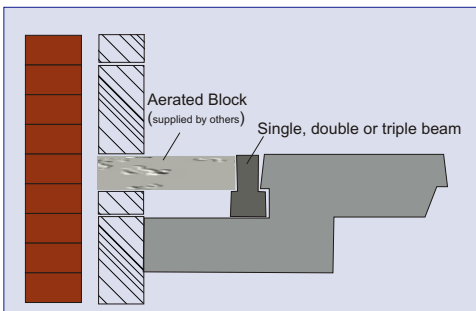

Section A-A

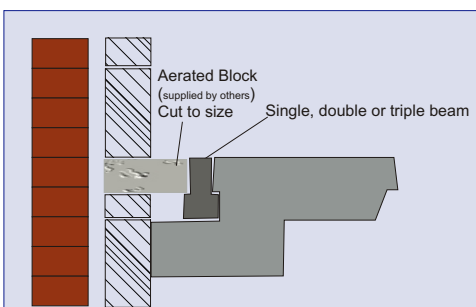

Section B-B

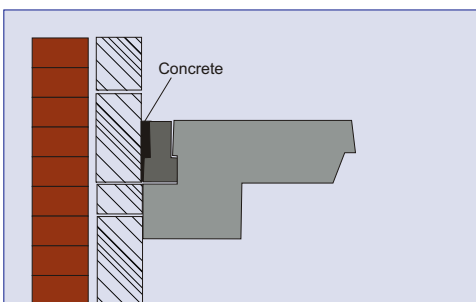

Section D-D

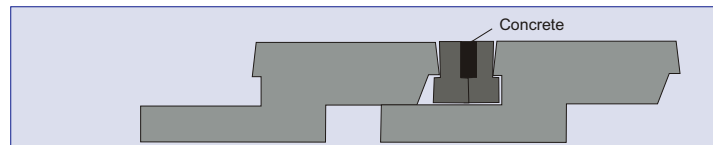

Section G-G

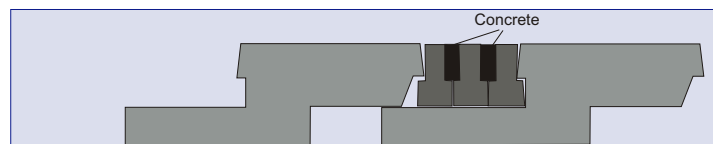

Section H-H

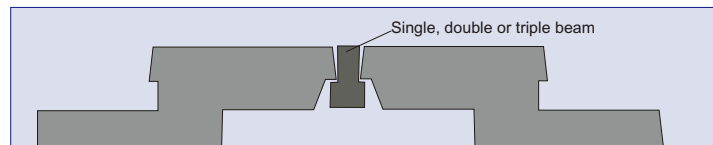

Section X-X

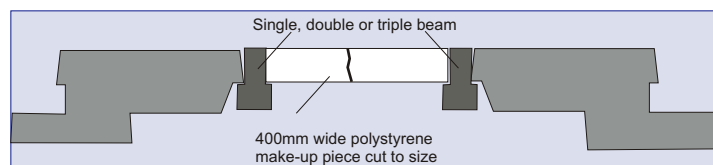

Section Y-Y

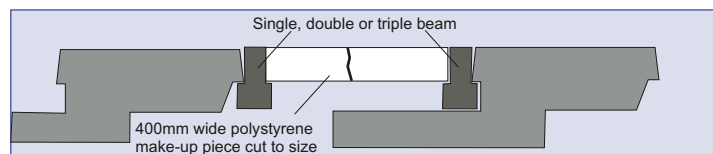

Section Q-Q

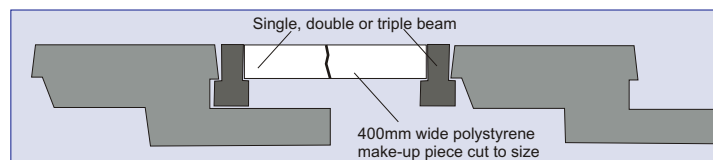

Section T-T